

BIOC3 V1

Biometric Reader



USER'S MANUAL

CONTENTS

1. DESCRIPTION	3
2. SPECIFICATIONS	3
3. MOUNTING	3
4. WIRING	4
5. CONNECTING BIOMETRIC READERS TO EWS CONTROLLER	4
5.1 CONNECTING BIOMETRIC READERS IN SAME RS-485 LINE WITH THE EWS CONTROLLERS	5
5.2 CONNECTING BIOMETRIC READERS WHEN ALL THE CONTROLLERS HAVE TCP/IP COMMUNICATION	5
6. CONNECTING BIOMETRIC READERS TO 3RD PARTY CONTROLLER	6
6.1 CONVERTERS PIN DESCRIPTION	6
7. ENROLLMENT	7
8. CONFIGURING THE BIOMETRIC READERS IN PROS SOFTWARE	7
8.1 ADDING BIOMETRIC READER	7
8.2 ENROLLING FINGERPRINTS FROM A READER	8
8.3 ENROLLING FINGERPRINTS FROM DESKTOP READER	9
8.4 DELETING FINGERPRINTS	10
8.5 UPLOADING THE FINGERPRINTS TO THE BIOMETRIC READERS	10
8.6 FIRMWARE UPDATE	11
8.7 SENSOR CALIBRATION	11
8.8 SEND CONFIGURATION	11
8.9 ADVANCED SETTING	11
9. CONFIGURING THE BIOMETRIC READERS IN BIOMANAGER	12
9.1 ADD PORTAL	12
9.2 ADD READER	12
9.3 EDIT READER	13
9.4 DELETE READER	13
9.5 ADD USER	14
9.6 DELETE FINGERPRINTS	14
9.7 UPLOADING THE FINGERPRINTS TO THE BIOMETRIC READERS9.12 CUSTOM WIEGAND	15
9.8 CUSTOM WIEGAND	16
10. WIEGAND PROTOCOL DESCRIPTION	17
11. SAFETY PRECAUTIONS	18

1. DESCRIPTION

BIOC3 is a Wiegand biometric reader for indoors access control applications. It offers storage up to 9500 fingerprints and programmable Wiegand Output (8 to 128 bits).

Configuration of the readers and fingerprint enrollment is done through PC Software.

Connection between the biometric readers is RS-485 and it is used for fingerprint transfer and configuration.

When used with third party controllers, the connection between the Biometric readers and the PC is done through a converter (CNV200-RS-485 to USB or CNV10000-RS-485 to TCP/IP). Only one converter is needed per system (one converter for 1, 2, 3...30, 31 Biometric readers)

The tamper switch output can trigger the alarm system, if an attempt is made to open or remove the unit from the wall.

2. SPECIFICATIONS

Fingerprint capacity	up to 9500 fingerprints
Technology	Biometry
Authentication	Finger
Fingerprints per user	1-10 fingerprints
Interface	Wiegand 8 to 128 bits; Default: Wiegand 26bit
Protocol programming	By PROS software (EWS system) and BIOMANAGER (all access control systems)
Cable distance	150m
Fingerprint Sensor Type	Capacitive
1:1000 identification time	970 msec, including feature extraction time
Fingerprint enrolment	On the reader or from the USB desktop reader
Panel Connection	Cable, 0.5m
Green and Red LED	Externally Controlled
Orange LED	Idle mode
Buzzer	Yes
Backlight ON/OFF	Yes, by software settings
Tamper	Yes
Consumption	100mA
IP Rating	54
Power supply	9-14V DC
Operating Temperature	0°C to +40°C, non-condensing
Dimensions (mm)	92 x 51 x 25
Housing	Moulded Aluminium

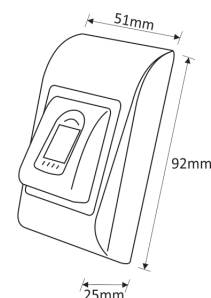

3. MOUNTING

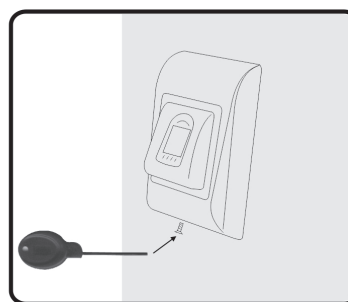
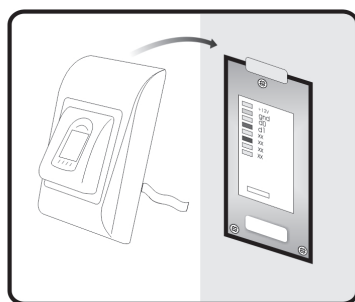
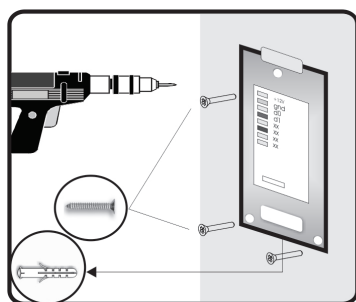

4. WIRING

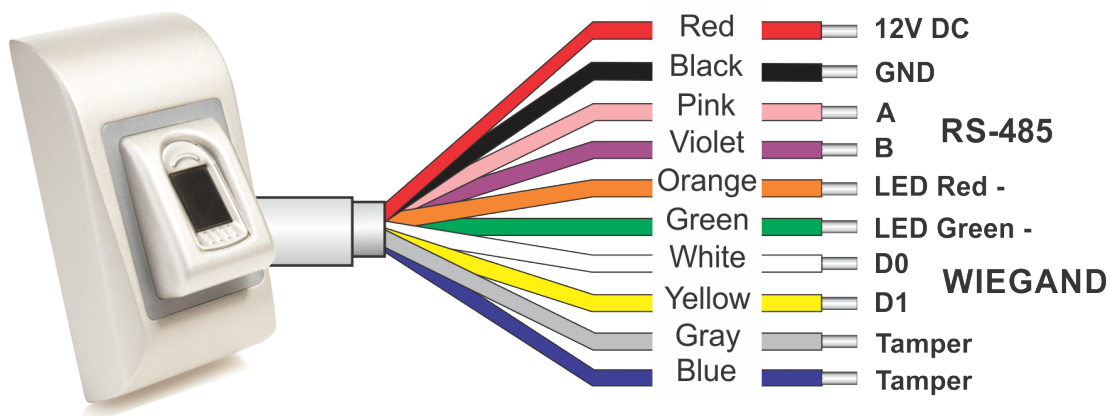

12V DC	9-14V DC
GND	ground
A	RS-485 A
B	RS-485 B
LR-	Red LED -
LG-	Green LED -
D1	Data 1
D0	Data 0
Tamper	Tamper Switch(NO)
Tamper	Tamper Switch(NO)

5. CONNECTING BIOMETRIC READERS TO EWS CONTROLLER

- The Biometric readers can be connected to virtually any controller that conforms to Wiegand format standards (standard Wiegand 26bit or self-defined Wiegand).
- The lines D0 and D1 are the Wiegand lines and the Wiegand Number is sent through them.
- The RS-485 line (A, B) is used for fingerprint transfer and reader settings.
- The Biometric readers must be powered from the controller.
- If you use different power supply for the biometric reader, connect the GND from the both devices to ensure correct transfer of the wiegand signal
- When you have connected the reader and powered on, the LED should flash in orange light + 2 beeps. This lets you know it's on and ready for use.
- Fingerprint enrollment is done from the PC Software. Connection between the Biometric readers and the PC must be established.

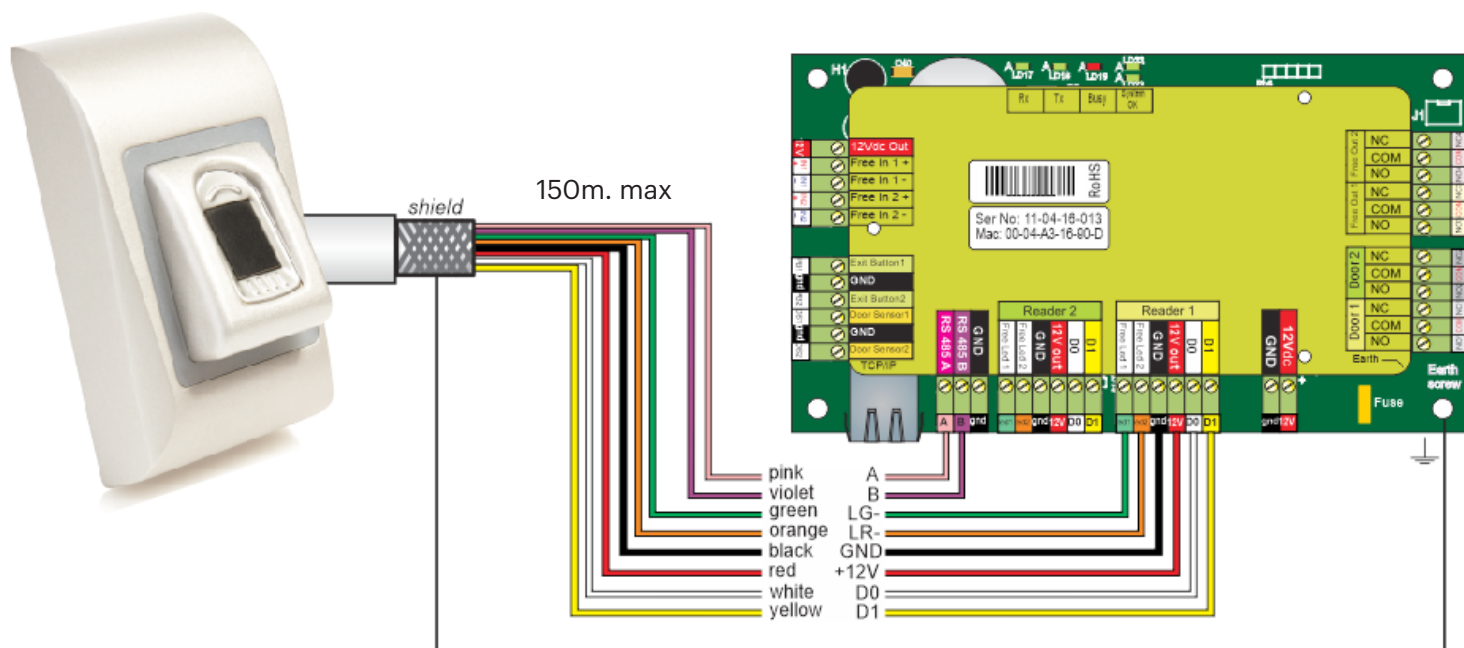

5.1 CONNECTING BIOMETRIC READERS IN SAME RS-485 LINE WITH THE EWS CONTROLLERS

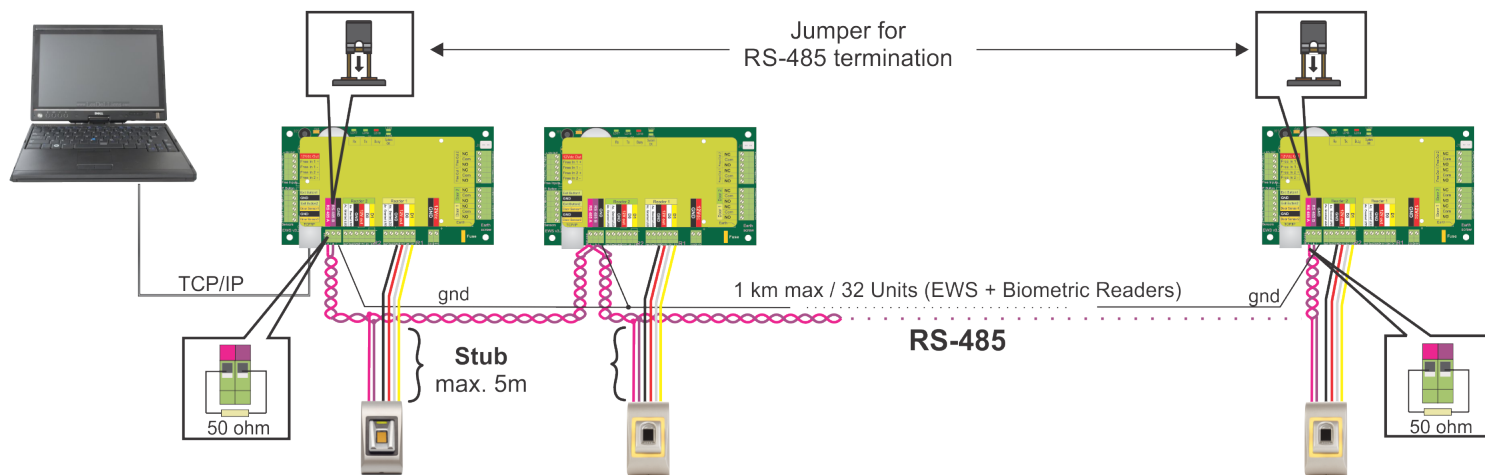

- The Biometric readers are connected through RS-485 bus. The same RS-485 bus that the EWS controllers are connected to.
- Maximum units in one network (EWS + Biometric readers) is 32.
- If there are more than 32 units in one network, please utilize RS-485 HUB to connect.
- The RS-485 Line should be configured in the form of a daisy chain, NOT in a form of a star. If star must be used in some points, keep the stubs from the RS-485 backbone as short as possible. Maximum length of the stub is dependant of the installation (total number of devices in RS-485 line (total cable length, termination, cable type...) so recommendation is to keep stubs shorter than 5 meters, keeping in mind that this can be possible reason for errors in communication with PC software
- The cable must be twisted and shielded with a min. 0.2 mm² cross section.
- Connect the ground (OV) of each unit in the RS-485 Line using a third wire in the same cable.
- The shield of the communication cable between two devices must be connected to the EARTH from ONE side of the RS-485 Line. Use the side that has earth connection to the building's grounding network.

5.2 CONNECTING BIOMETRIC READERS WHEN ALL THE CONTROLLERS HAVE TCP/IP COMMUNICATION

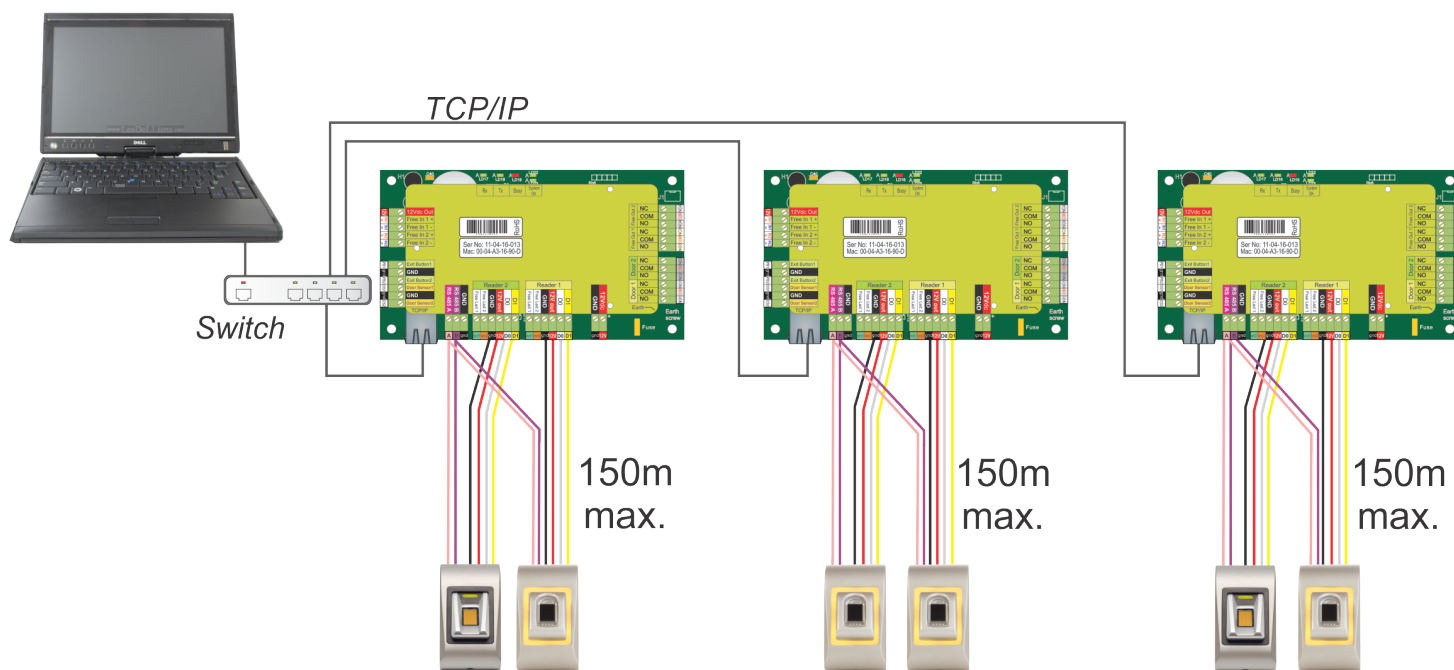

- When all the controllers are connected via TCP/IP, then the RS-485 network becomes local (from Reader 1 to the Controller then to the Reader 2).
- Connect the readers directly to the RS-485 terminals in each controller.
- If the distance Reader-Controller is high (50meters) and if the communication with the reader can not be established, then terminate the RS-485 network by closing the jumper in the EWS Controller or as described in chapter 4.

6. CONNECTING BIOMETRIC READERS TO THIRD PARTY CONTROLLERS

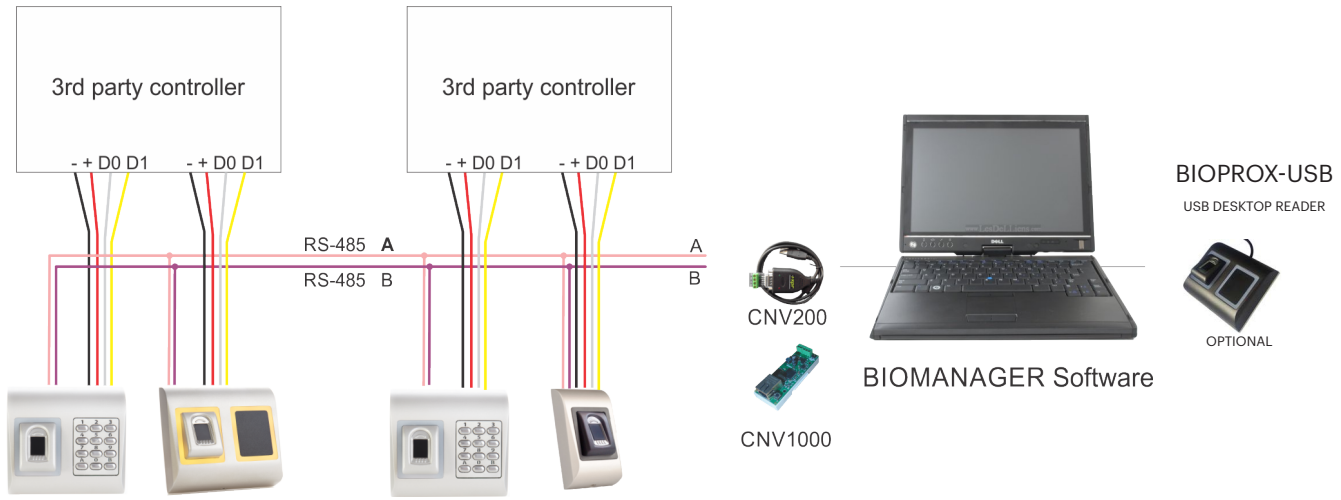

- Connect the lines D0, D1, Gnd and +12V to the third party controller.
- Connect the RS-485 Line (A, B) to the converter. Connect the converter in the PC.
- Fingerprint enrollment is done from the PC Software. Connection between the Biometric readers and the PC must be established.
- The Biometric readers communicate with each other with a RS-485 and with the PC Software through a Converter.
- The RS-485 Line should be configured in the form of a daisy chain, NOT in a form of a star. Keep the stubs from the RS-485 back bone as short as possible (not more than 5 meters)
- Only one converter per installation is needed, not per reader.

6.1 CONVERTERS PIN DESCRIPTION

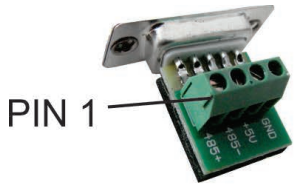

PIN 1



CNV200

Converter RS-485 to USB
Requires installation as USB serial device (refer to CNV200 Manual). The Drivers are located on the CD.

CNV1000

Converter RS-485 to TCP/IP
Does not require installation. IP address set through Internet Browser(refer to CNV1000 Manual)

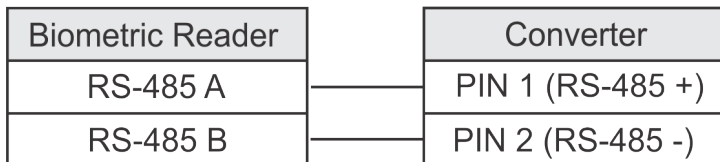

7. ENROLLMENT

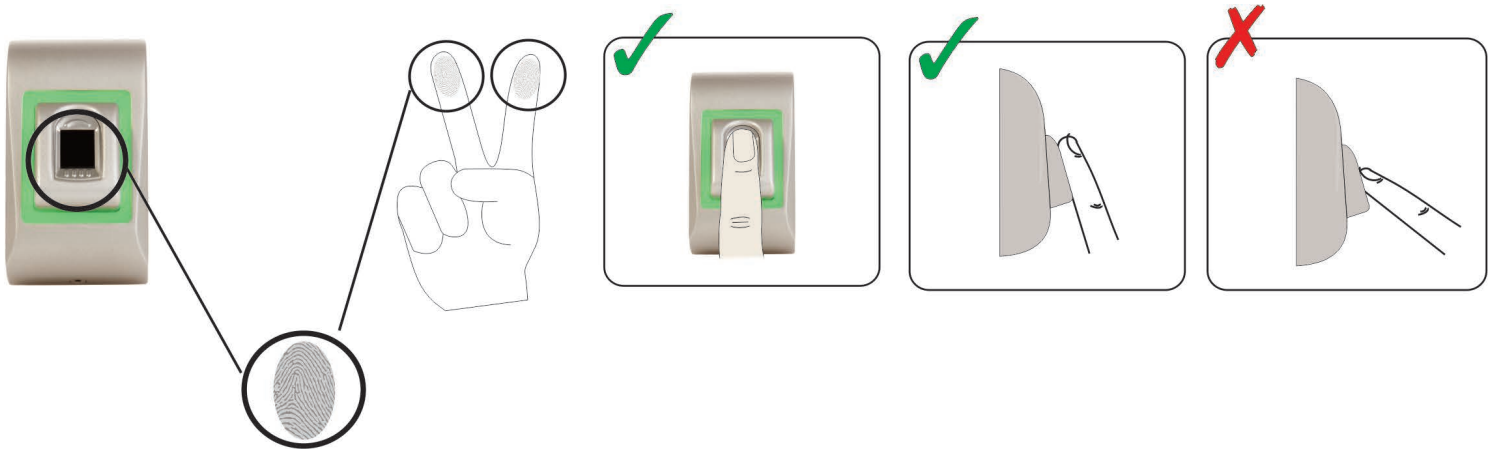

8. CONFIGURING THE BIOMETRIC READERS IN PROS CS SOFTWARE

8.1 ADDING BIOMETRIC READER

1. Expand the Door item to view the readers
2. Right click on the reader and select properties (8.1)
3. In the Basic tab, for "Type" of the Reader select "BIOC3". (8.2)
4. After selecting the type, a third tab will appear "Biometric". Go to that tab and put the serial number of the Biometric Reader. (8.3)

Important Note: The serial number of the reader can be found on a sticker inside the reader, on the packaging box and it can be search from the software (right click on the portal/search devices/readers). (8.4 & 8.5)

To check if the reader is On Line, right click on the reader and select "Check version". In the Event Window a message should appear "Device ON Line, Type: BIOC3" (8.6)

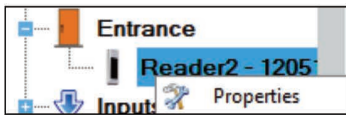

8.1

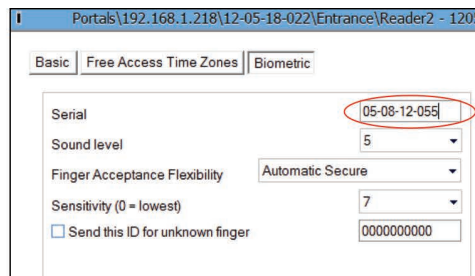

8.3

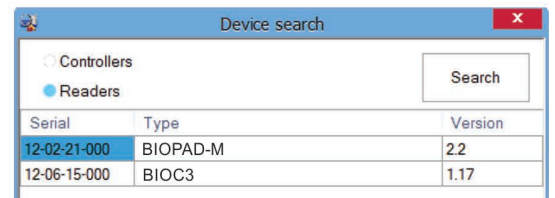

8.5

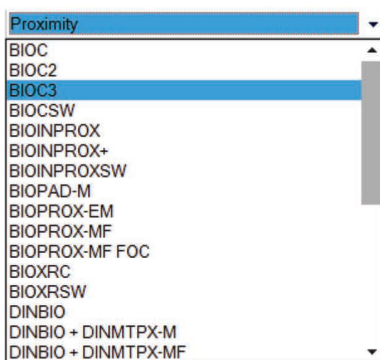

8.2

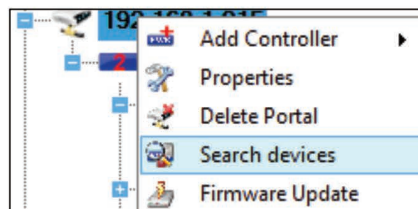

8.4

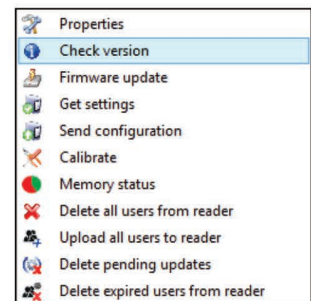

8.6

8.2 ENROLLING FINGERPRINTS FROM A READER

1. Open the Users Window and create a new user. Click on "New User", put a name and ID(card number). (8.7)
 2. Go to the "Biometric" Tab
 3. Select the reader(with left click) from which the enrollment will be done. (8.8)
 4. Right click on the fingertip and select enroll. (8.9)
 5. In the next 25 sec. present the finger on the selected reader and the finger tip will turn red, with the percentage of successful enrollment shown next to the fingertip. (8.10)
- In these 25 sec. the reader will continuously blink in orange.
6. Repeat point 4&5 for each finger that should be enrolled.
 7. Click on "Save New" and the fingerprint will be sent automatically to all Biometric Readers where that user has access, i.e. to all the readers according to the Access Level assign to that user.

Example:

If the user has "Unlimited" Access level then the fingerprints will be sent to all readers, if the user has Access level only for Reader1 and Reader 3 then the fingerprints will be sent only to those two readers.

Note:

To check if all the fingerprints are sent to the reader, right click on the reader and select "Memory Status". (8.11)

In the event window a line will appear indicating the number of fingerprints stored in the reader. (8.12)

Note:

If more fingerprints are added for one user, all fingerprints will send the same Wiegand Code to the controller, the one written in the field User ID(card Number).

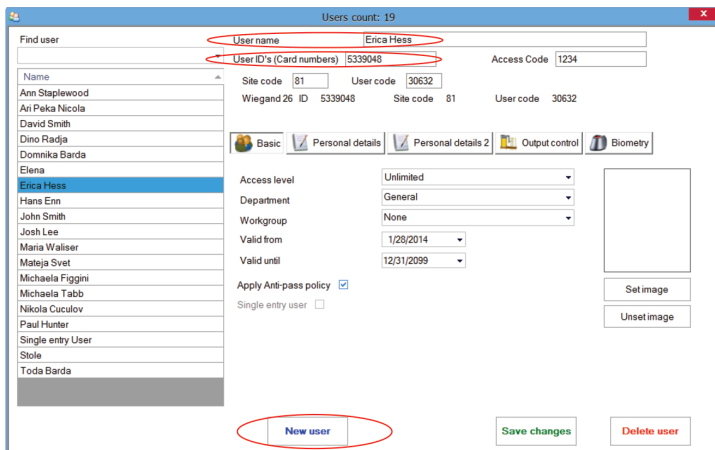

8.7

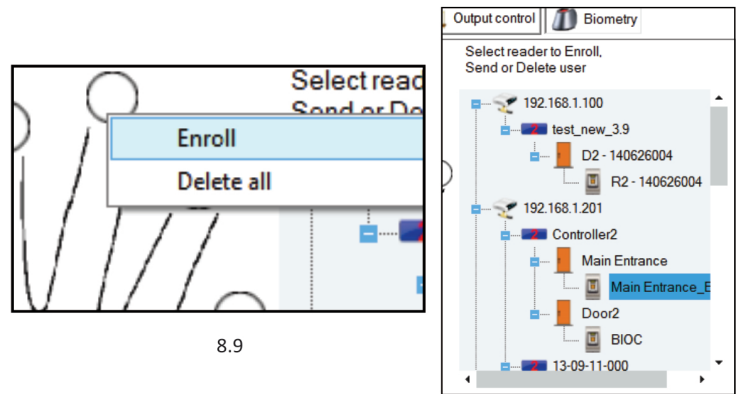

8.9

8.8

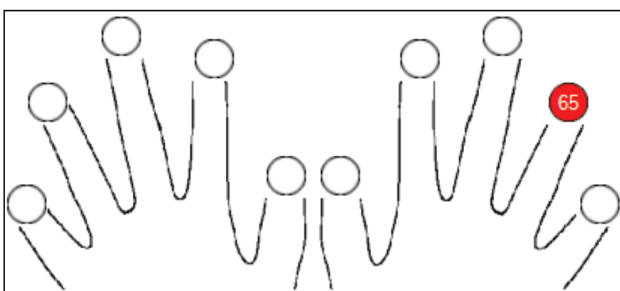

8.10

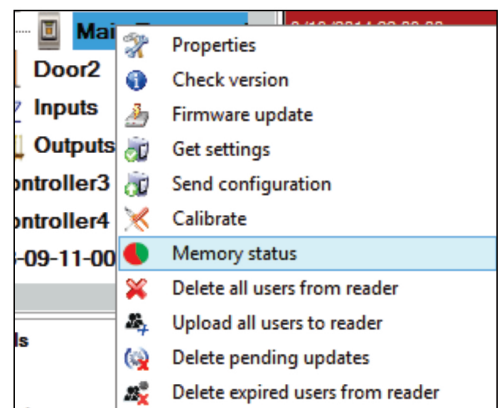

8.11

Reader	Door	Event
BIOC3		Enrolled fingers : 28

8.12

8.3 ENROLLING FINGERPRINTS FROM DESKTOP READER

Plug the Desktop Reader in the PC. It is installed in the same way as a USB Device. When the desktop reader has been installed it will automatically appear in the Software. (8.13)

1. Open the Users Window and create a new user.
Click on "New User", put a name and ID(card number). (8.7)
2. Go to the "Biometric" Tab
3. Select the USB desktop Reader (with left click).
4. Place the finger on the BIOPROX-USB, right click on the fingertip and select enroll. (8.9)
5. The finger tip will turn red, with the percentage of successful enrollment shown next to the fingertip. (8.10)
6. Repeat point 5 for each finger that should be enrolled.
7. Click on "Save New" and the fingerprint will be sent automatically to all Biometric Readers where that user has access, i.e. to all the readers according to the Access Level assign to that user.

If the reader is off line, the fingers will be sent upon the connection is established between PROS server and the reader. No need for additional enrollment or actions. The fingerprints will be sent as soon as communication is established.

Example:

If the user has "Unlimited" Access level then the fingerprints will be sent to all readers, if the user has Access level only for Reader1 and Reader 3 then the fingerprints will be sent only to those two readers.

Note:

To check if all the fingerprints are sent to the reader, right click on the reader and select "Memory Status". (8.11)

In the event window a line will appear indicating the number of fingerprints stored in the reader. (8.12)

Note:

If more fingerprints are added for one user, all fingerprints will send the same Wiegand Code to the controller, the one written in the field User ID(card Number).

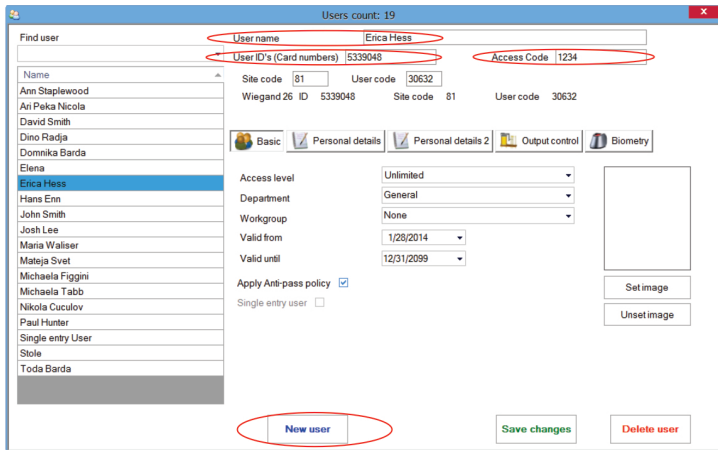

8.7

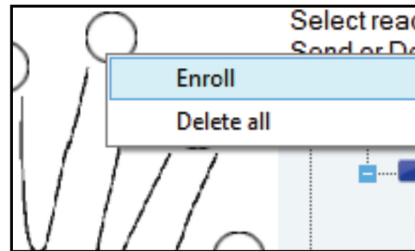

8.9

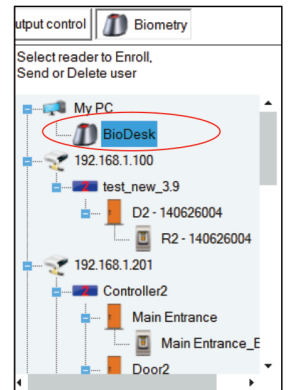

8.13

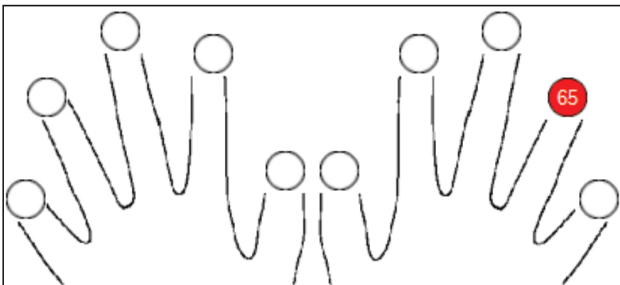

8.10

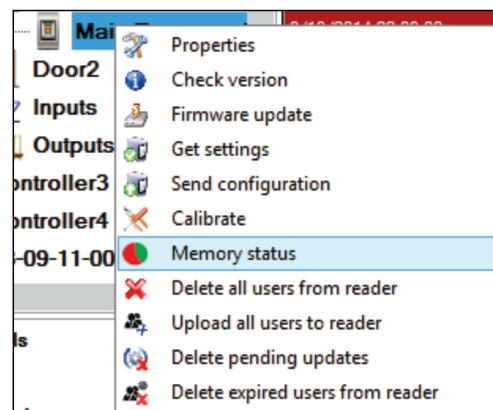

8.11

Reader	Door	Event
BIOC3		Enrolled fingers : 28

8.12

8.4 DELETING FINGERPRINTS

In General, the fingerprints are stored in the Biometric reader and in the Software. Deleting can be done only in the readers or from both places.

Deleting one user from the biometric reader

Select the User
Click on "Delete User". The User together with its fingerprints will be deleted from both the software and the fingerprint readers. (8.14)

Deleting all users from the biometric reader

Right click on the reader and select "Delete all users from reader" (8.15)

Delete one or more fingerprints

Select the User and open the "Biometric" tab
Go to the fingertip that needs to be deleted, right click and select "Delete" for one finger or "Delete All" for all fingers of the User.
Click "Save Changes".

With this procedure the User's fingerprints are deleted from the software and from the reader. (8.16)

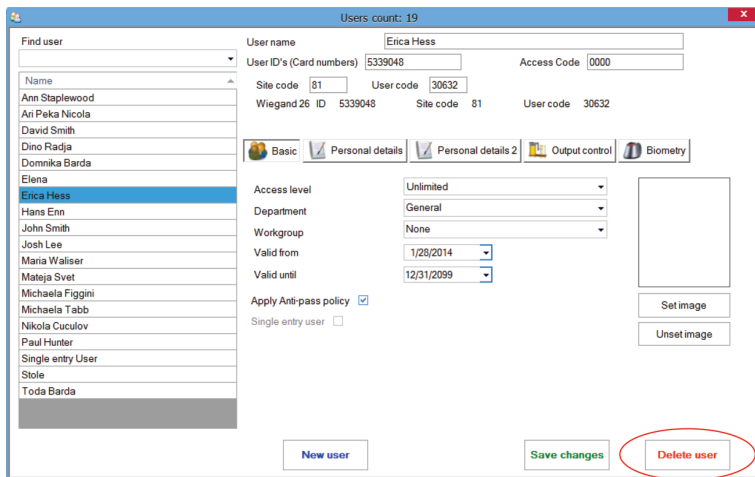

8.14

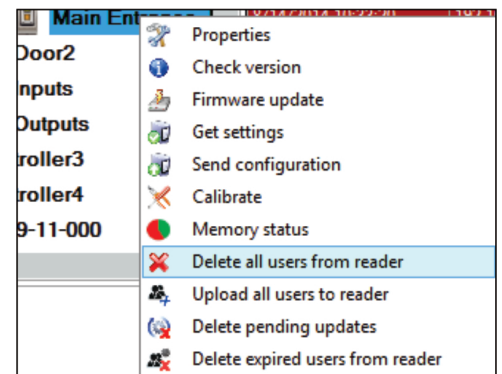

8.15

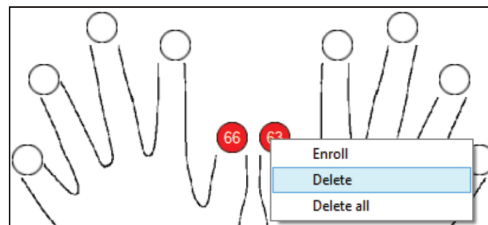

8.16

8.5 UPLOADING THE FINGERPRINTS TO THE BIOMETRIC READERS

Right click on the biometric reader
Select "Upload all users to reader"
While receiving the fingerprints the reader will blink in orange.

Note: Use this feature when you change or add a reader, if pending tasks are deleted in the software or if there are doubts that fingerprints in the reader memory are not synchronized with the software database.

In normal usage, the fingerprints are sent automatically and this feature is not used.

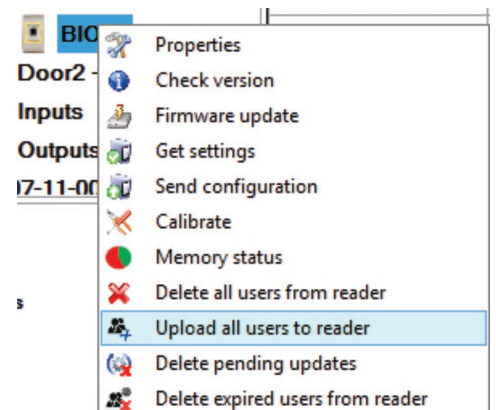

8.17

8.6 FIRMWARE UPDATE

Right-click on the reader and select Firmware update menu (8.18)
 On the Firmware update window, click on the Browse button (8.19). The default location of the firmware files installed with PROS CS is in the folder "Firmware".
 Select the firmware file with a "xhc" extension.
 Click on the Upload button
 Important: Wait for the update end message. Do not turn off the reader, the software or any communication device in between during the entire process.

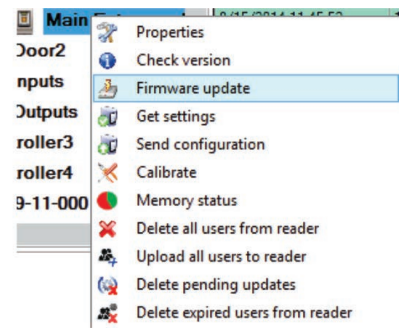

8.18

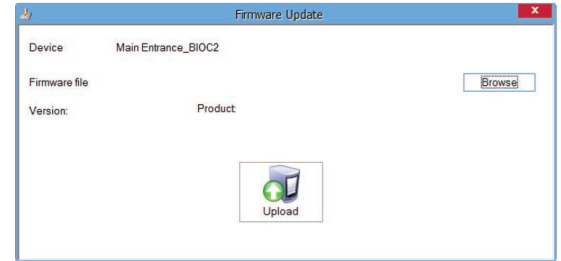

8.19

8.7 SENSOR CALIBRATION

Right click on the biometric reader and select "Calibrate" and wait for confirmation message.

Note: It is recommended to do a calibration while commissioning the reader and in cases when there are problems with reading the fingers

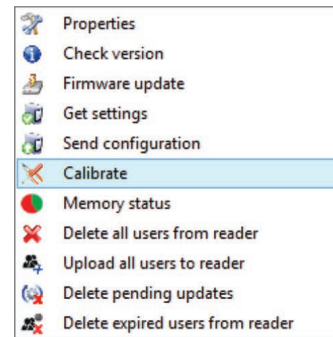

8.8 SEND CONFIGURATION

- Right-click on the reader and select the Send configuration menu
- See the events panel to check the configuration flow

Note: The biometric reader gets its settings automatically. This function is used if the reader was off line while making the changes.

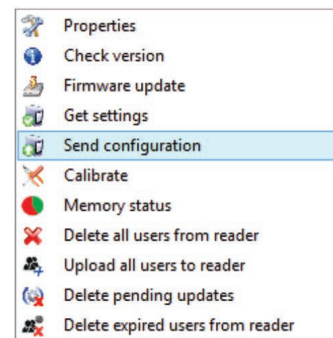

8.9 ADVANCED SETTINGS

Send This ID for:

Unknown Finger sends the desired Wiegand when an unknown finger is applied.

Click on the Save & Exit button

Sound level:

Sound level of the device (ON or OFF)

Backlight:

Backlight of the device (ON or OFF)

Finger Acceptance Flexibility:

Accepted tolerance. The recommended value is "Automatic Secure".

Sensitivity:

Bio-sensor sensitivity, the recommended value is 7, most sensitive.

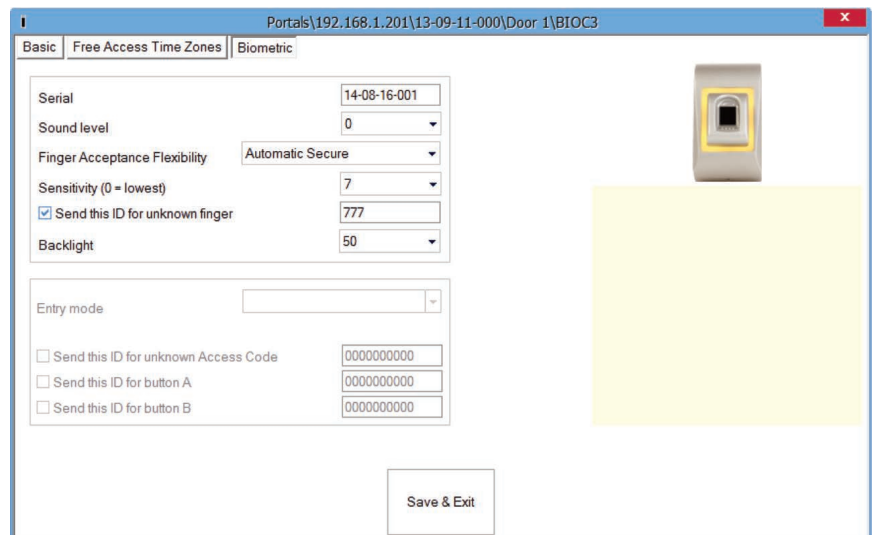

9. CONFIGURING THE BIOMETRIC READERS IN BIOMANAGER CS

BIOMANAGER CS is software for fingerprint management of XPR Biometric readers, when used with third party access controllers.

Main functions:

- Fingerprint Enrollment

It can be done by ANY Biometric reader in the network or by Desktop (USB) Biometric reader.

- Fingerprint Transfer

Finger templates can be sent to any Reader in the Network. Different Users can be sent to different Biometric readers.

- PIN Codes management and transfer

PIN Code length configuration (1 to 8 digits) and PIN Code transfer.

- Wiegand Output Configuration

The Wiegand output of the Biometric reader can be customized bitwise.

9.1 ADD PORTAL

9.1

9.2

Right-click on "Portal" and select "Add Portal".

If the converter used for the Biometric Readers is RS-485 to TCP/IP converter, then create Portal by adding the IP Address of the converter.(9.1)

If the converter used for the Biometric Readers is RS-485 to USB converter, then create Portal by adding the COM port of the converter.(9.2)

9.2 ADD READER

Right-click on the portal connected to the reader and select Add reader

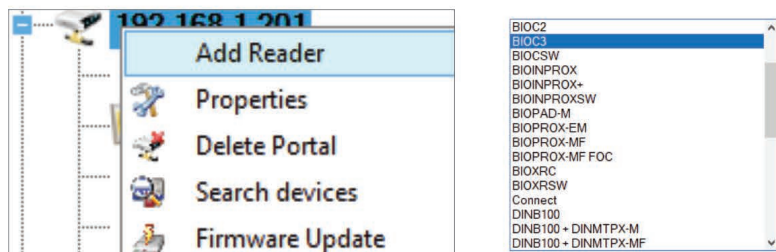

Click on **Save** and the reader icon appears under the selected portal

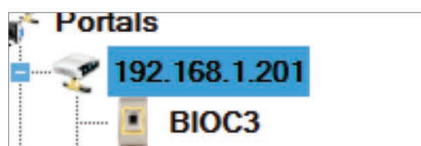

Fill the Reader form

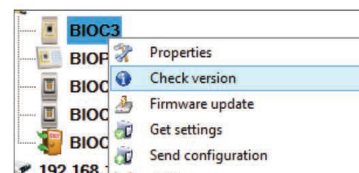

Right-click on reader and select **Check Version**

If reader is online, new line is added on top of the event table

Time	Portal	Controller	Reader	Door	Event	User
8/6/2015 12:57:03	192.168.1.201		BIOC3		Device online	Type: BIOC3 Version: 1.11

If reader is not online, following line is added on top of the event table

Time	Portal	Controller	Reader	Door	Event	User
8/6/2015 12:58:42	192.168.1.215		BIOPROX-EM		No response	

If reader is online, right click on reader and select **Upload configuration**

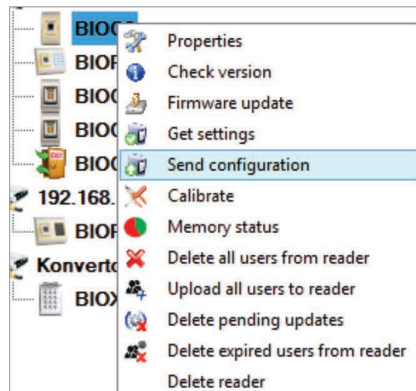

Check at event table if configuration was successful

Time	Portal	Controller	Reader	Door	Event	User
8/6/2015 12:59:46	192.168.1.201		BIOC3		Configure wiegand	Success
8/6/2015 12:59:46	192.168.1.201		BIOC3		Configure Sensitivity2	Success
8/6/2015 12:59:46	192.168.1.201		BIOC3		Configure Sensitivity	Success
8/6/2015 12:59:46	192.168.1.201		BIOC3		Configure flexibility level2	Success
8/6/2015 12:59:45	192.168.1.201		BIOC3		Configure flexibility level	Success
8/6/2015 12:59:45	192.168.1.201		BIOC3		Configure parameters	Success

9.3 EDIT READER

Right-click on the reader and select **Properties**

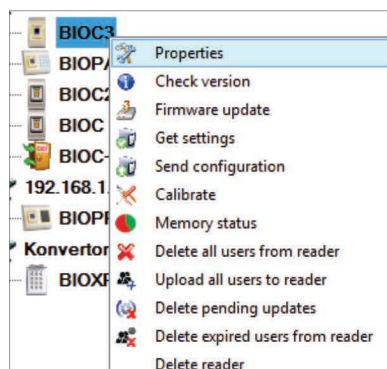

Check at event table if configuration was successful

Time	Portal	Controller	Reader	Door	Event	User
8/6/2015 12:59:46	192.168.1.201		BIOC3		Configure wiegand	Success
8/6/2015 12:59:46	192.168.1.201		BIOC3		Configure Sensitivity2	Success
8/6/2015 12:59:46	192.168.1.201		BIOC3		Configure Sensitivity	Success
8/6/2015 12:59:46	192.168.1.201		BIOC3		Configure flexibility level2	Success
8/6/2015 12:59:45	192.168.1.201		BIOC3		Configure flexibility level	Success
8/6/2015 12:59:45	192.168.1.201		BIOC3		Configure parameters	Success

Edit reader properties and click **Save** button

9.4 DELETE READER

Right-click on the reader and select **Delete reader**

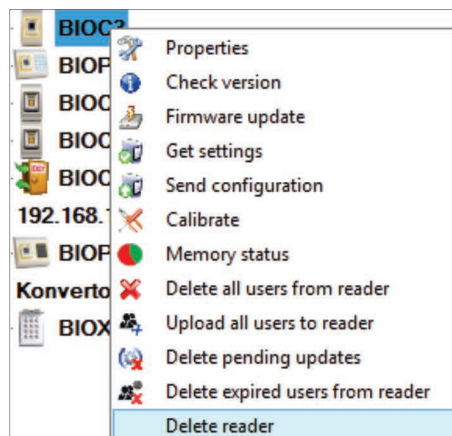

Time	Portal	Controller	Reader	Door	Event	User
10/28/2015 14:27:19	Konvertor_192.168.		asfdasd		Reader deleted	

9.5 ADD USER

1. Open the Users Window and create a new user.
Click on "New User", put a name, ID(card number). (8.7)
 2. Go to the "Biometric" Tab
 3. Select the reader(with left click) from which the enrollment will be done. (8.8)
 4. Right click on the fingertip and select enroll. (8.9)
 5. In the next 25 sec. present the finger on the selected reader and the finger tip will turn red, with the percentage of successful enrollment shown next to the fingertip. (8.10)
- In these 25 sec. the reader will continuously blink in orange.
6. Repeat point 4&5 for each finger that should be enrolled.
 7. Click on "Save New" and the fingerprint will be sent automatically to all Biometric Readers where that user has access, i.e. to all the readers according to the Access Level assign to that user.

Example:

If the user has "Unlimited" Access level then the fingerprints will be sent to all readers, if the user has Access level only for Reader1 and Reader 3 then the fingerprints will be sent only to those two readers.

Note:

To check if all the fingerprints are sent to the reader, right click on the reader and select "Memory Status". (8.11)

In the event window a line will appear indicating the number of fingerprints stored in the reader. (8.12)

Note:

If more fingerprints are added for one user, all fingerprints will send the same Wiegand Code to the controller, the one written in the field User ID(card Number).

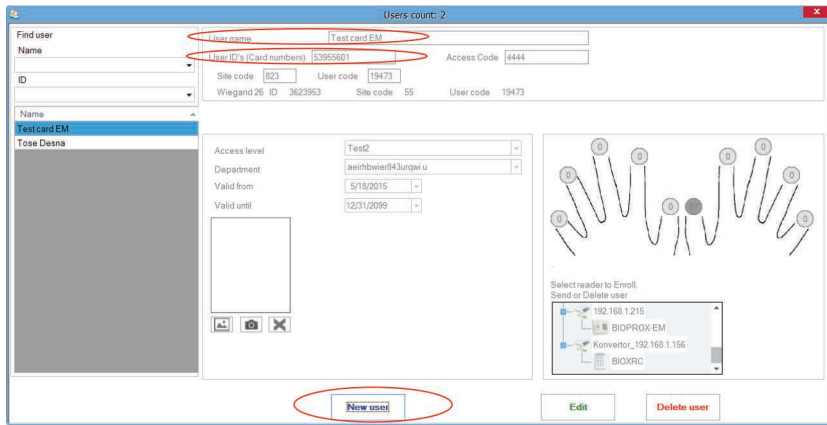

8.7

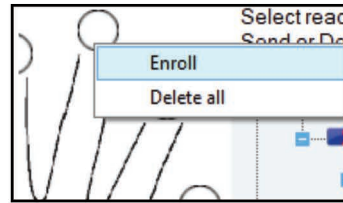

8.9

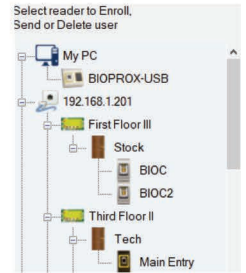

8.8

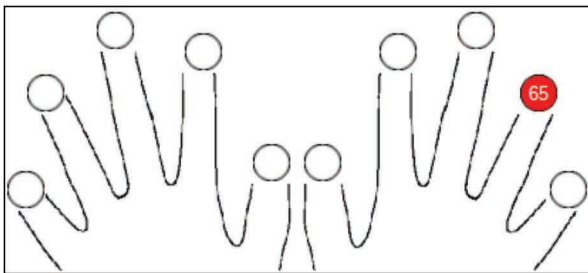

8.10

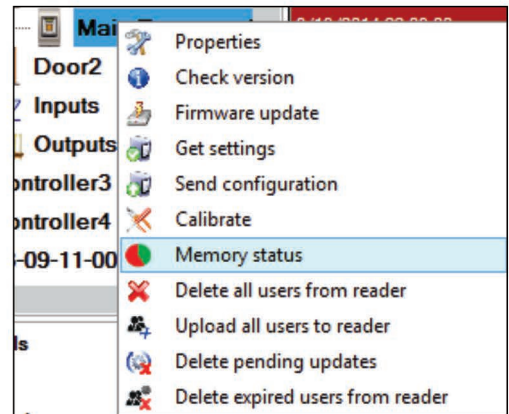

8.11

Reader	Door	Event
BIOC3		Enrolled fingers : 3

8.12

9.6 DELETING FINGERPRINTS

In General, the fingerprints are stored in the Biometric reader and in the Software. Deleting can be done only in the readers or from both places.

Deleting one user from the biometric reader

Select the User

Click on "Delete User". The User together with its fingerprints will be deleted from both the software and the fingerprint readers. (8.14)

Deleting all users from the biometric reader

Right click on the reader and select "Delete all users from reader" (8.15)

Delete one or more fingerprints

Select the User and open the "Biometric" tab

Go to the fingertip that needs to be deleted, right click and select "Delete" for one finger or "Delete All" for all fingers of the User. Click "Save Changes".

With this procedure the User's fingerprints are deleted from the software and from the reader. (8.16)

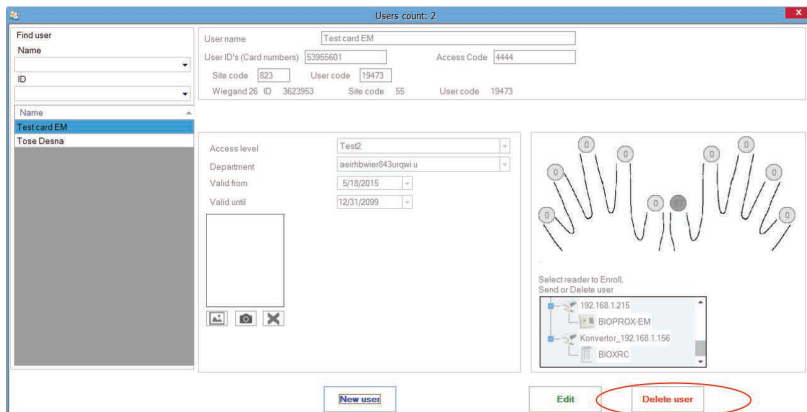

8.14

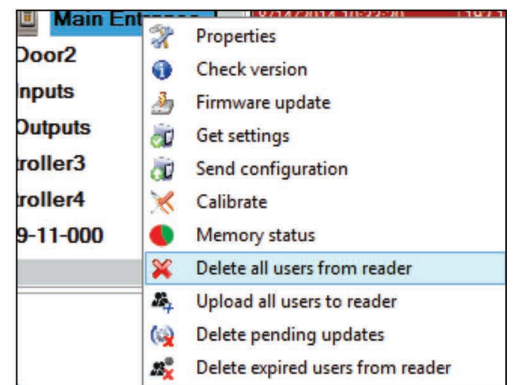

8.15

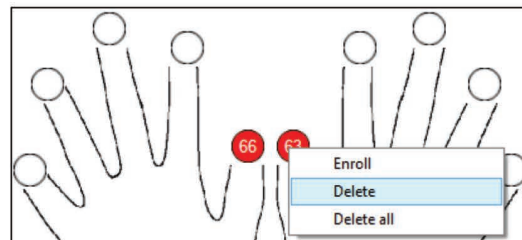

8.16

9.7 UPLOADING THE FINGERPRINTS TO THE BIOMETRIC READERS

Right click on the biometric reader

Select "Upload all users to reader"

While receiving the fingerprints the reader will blink in orange.

Note: Use this feature when you change or add a reader, if pending tasks are deleted in the software or if there are doubts that fingerprints in the reader memory are not synchronized with the software database.

In normal usage, the fingerprints are sent automatically and this feature is not used.

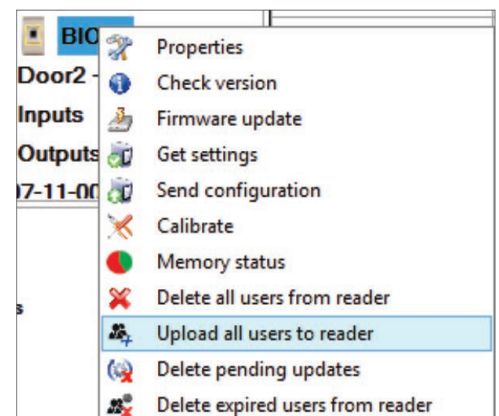

8.17

9.8 CUSTOM WIEGAND

BIOMANAGER CS has defined Wiegand 26, 30, 34, 40 bit as standard options and other 3 Wiegand settings as user definable.

To setup custom Wiegand format
Select **Wiegand** menu from **Settings**

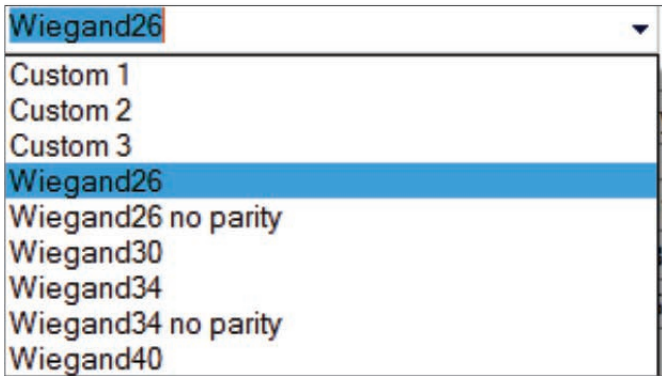
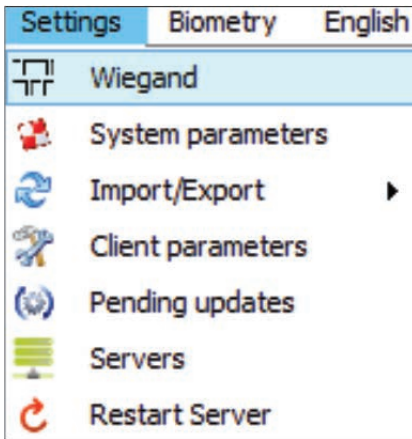

At Wiegand setup window select one from customs Wiegand

Set Wiegand parameter

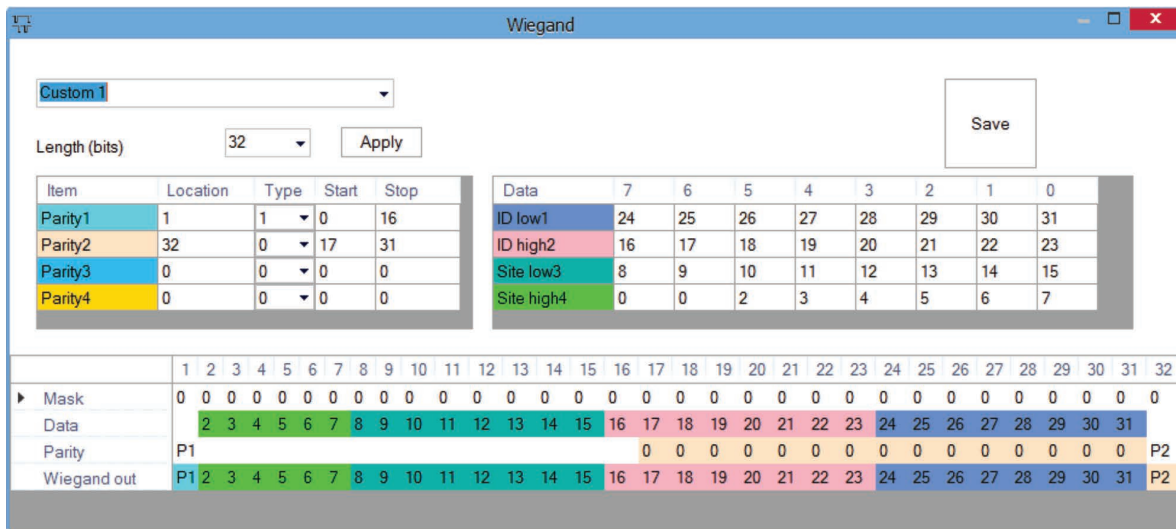

Click on **Save** button

Wiegand settings are out of scope for common end user. Please ask your installer to set the parameters and do not change it later.

For more information please refer to BIOMANAGER CS User Manual

10. WIEGAND PROTOCOL DESCRIPTION

The data is sent over the lines DATA 0 for the logic "0" and DATA 1 for the logic "1". Both lines use inverted logic, meaning that a pulse low on DATA 0 indicates a "0" and a pulse low on DATA 1 indicates a "1". When the lines are high, no data is being sent. Only 1 of the 2 lines (DATA 0 / DATA 1) can pulse at the same time.

Example: data 0010...

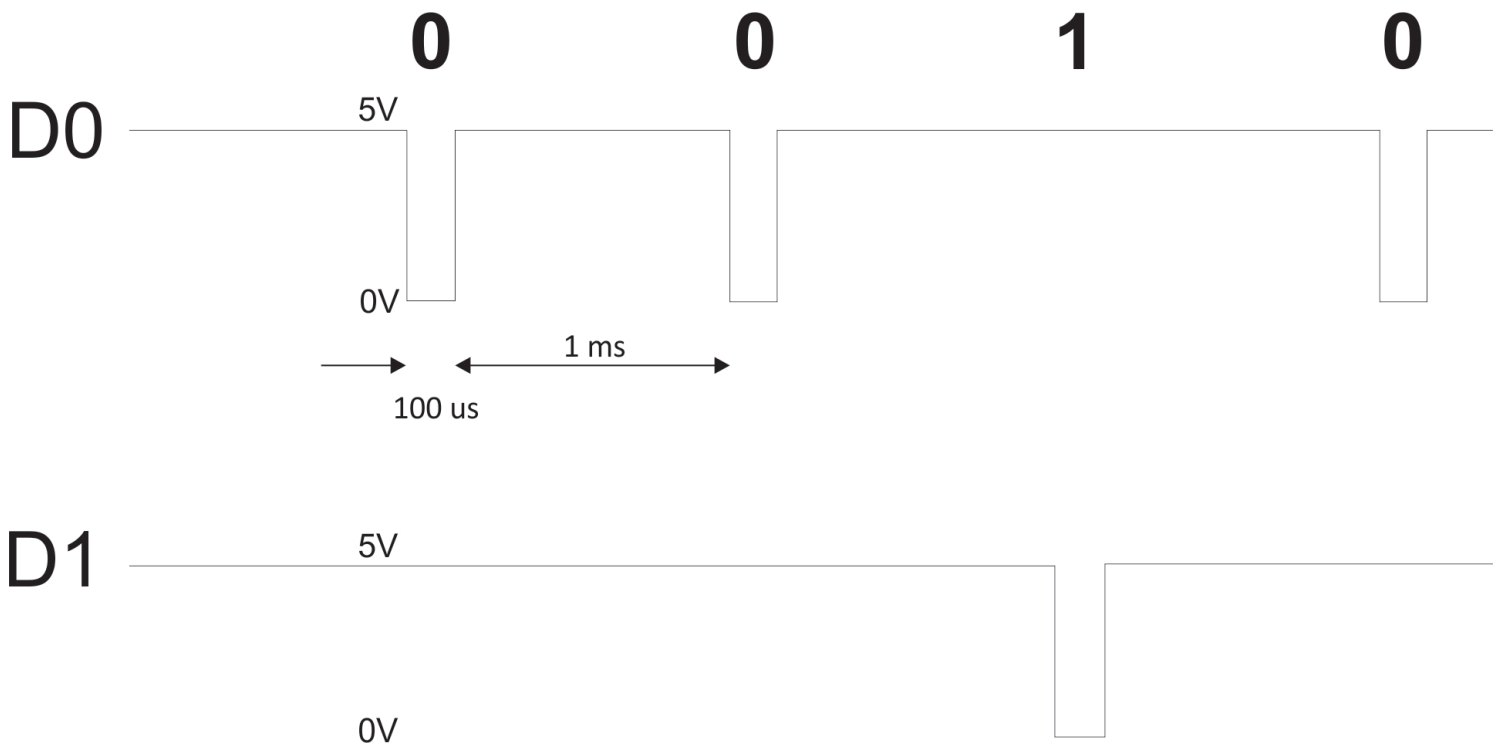

Data bit 0 = approximately 100 us (microseconds)

Data bit 1 = approximately 100 us (microseconds)

Time between two data bits: approximately 1 ms (millisecond). Both data lines (D0 and D1) are high.

Description for the 26 bits Wiegand format

Each data block consists of a first parity bit P1, a fixed 8 bits header, 16 bits of user code and a 2nd parity bit P2. Such a data block is shown bellow:

	Parity bit (bit 1)	+ 8 bits header	+	16 bits user code = 2 bytes	+	Parity bit (bit 26)
	P1	XXXXXXXX		XXXXYYYY YYYYYYYY		P2
Example:	1	170		31527		0
		10101010		01111011 00100111		

Note: Parity bits are calculated as follows:

P1 = even parity calculated over the bits 2 to 13 (X)

P2 = odd parity calculated over the bits 14 to 25 (Y)

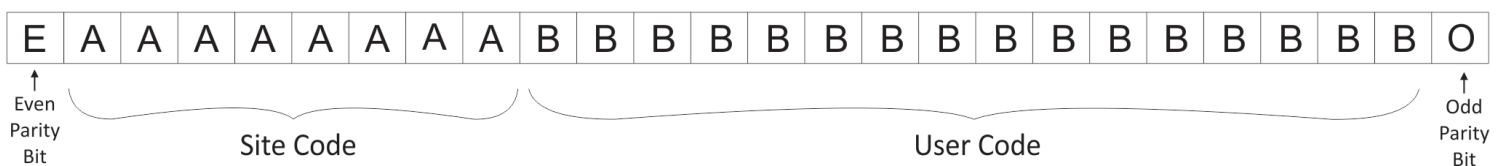

11. SAFETY PRECAUTIONS

Do not install the device in a place subject to direct sun light without protective cover.

Do not install the device and cabling close to a source of strong electro-magnetic fields like radio-transmitting antenna.

Do not place the device near or above heating equipments.

If cleaning, do not spray or splash water or other cleaning liquids but wipe it out with smooth cloth or towel.

Do not let children touch the device without supervision.

Note that if the sensor is cleaned by detergent, benzene or thinner, the surface will be damaged and the fingerprint can't be entered.

This product herewith complies with requirements of EMC directive 2014/30/EU. In addition it complies with RoHS2 directive EN50581:2012 and RoHS3 Directive 2015/863/EU.

